



SECRET JARDIN

---

**PRODUCT PRESENTATION  
2023**





**DUCTING FLANGE : GROW TENTS**



**SOCKS : GROW TENTS**



**LIGHTING**



**VENTILATION**



**GROW TENTS BUNDLES**



**ACCESSORIES**



**SPARE PARTS**

# secret JARDIN

## DARK STREET R4.00



**DS60** 60x60x158cm | **DS120W** 120x60x178cm | **DS90** 90x90x178cm | **DS150W** 150x77x200cm | **DS120** 120x120x200cm | **DR150** 150x150x217cm | **DR240W** 237x120x200cm | **DR300W** 297x150x217cm | **DR240** 237x237x200cm | **DR300** 297x297x217cm | **INT480** 270x300x233cm | **INT600** 590x360x233cm

| Ø16mm - M210D - DF16 | | Ø19mm - M210D - DF16 | | Poles Ø25mm - Mylar M400D - Techno DF25 | | Ø25mm - M900D - DF25/DFM315 |

## DARK PROPAGATOR R4.00

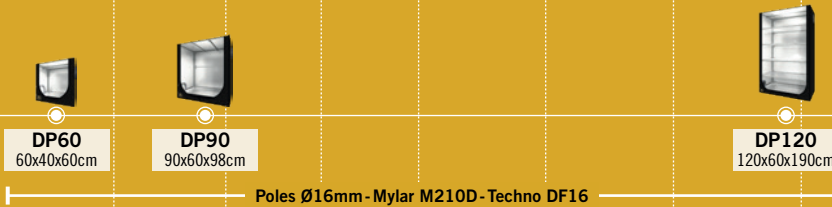

**DP60** 60x40x60cm | **DP90** 90x60x98cm | **DP120** 120x60x190cm

Poles Ø16mm - Mylar M210D - Techno DF16

## LODGE R4.00

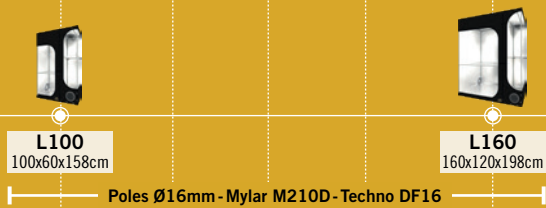

**L100** 100x60x158cm | **L160** 160x120x198cm

Poles Ø16mm - Mylar M210D - Techno DF16

## HYDRO SHOOT (SMALL) R2.00

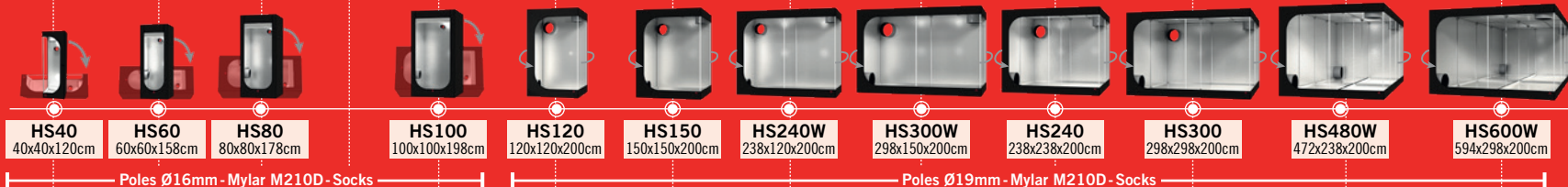

**HS40** 40x40x120cm | **HS60** 60x60x158cm | **HS80** 80x80x178cm | **HS100** 100x100x198cm | **HS120** 120x120x200cm | **HS150** 150x150x200cm | **HS240W** 238x120x200cm | **HS300W** 298x150x200cm | **HS240** 238x238x200cm | **HS300** 298x298x200cm | **HS480W** 472x238x200cm | **HS600W** 594x298x200cm

Poles Ø16mm - Mylar M210D - Socks

## HYDRO SHOOT (LARGE) R2.00

## SOCKS



Poles Ø19mm - Mylar M210D - Socks

0.16m<sup>2</sup>

0.64m<sup>2</sup>

1.00m<sup>2</sup>

2.25m<sup>2</sup>

4.50m<sup>2</sup>

9.00m<sup>2</sup>

18.00m<sup>2</sup>

Surface



## DUCTING FLANGE

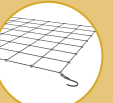

# SECRET JARDIN VS HYDRO SHOOT

DIFFERENT FEATURES, SAME HIGH QUALITY!



## DUCTING FLANGE

(SECRET JARDIN)



Ducting Flange

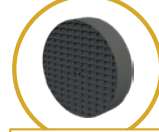

Light Baffle



Connectors



Cable Flange



PatchIT

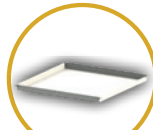

Water Tray



Space Booster

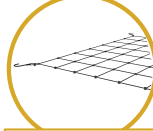

WebIT



CableIT



StrapIT



Handling

## SOCKS

(HYDRO SHOOT)



Cable Flange



Socks

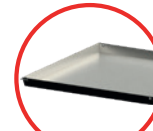

Water Tray



Handling

SAME HIGH END MATERIALS, SAME SPARE PARTS

DARK STREET R4.00

DARK ROOM R4.00

INTENSE R4.00

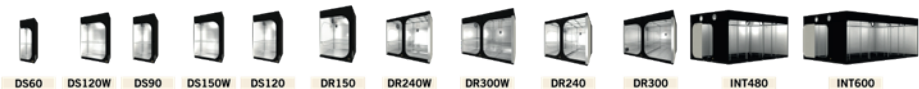

DS60 DS120W DS90 DS150W DS120 DR150 DR240W DR300W DR240 DR300 INT480 INT600

## DARK STREET



Ducting Flange DF16

Connector: Ø100 – 125 – 150mm

MYLAR 210D



Q195 Steel  
Ø16 – 19mm



Opening 270°  
Full plant access



Fully Pre-equipped  
Adapt to your needs

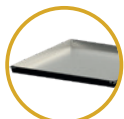

Water tray  
Strong & Removable



100% Lightproof  
Double-flap zip

## DARK ROOM

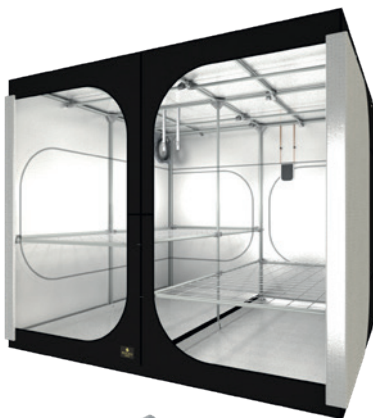

Ducting Flange DF25

Connector: Ø150 – 160 – 200 – 250mm

MYLAR 400D



#201 Stainless Steel  
Ø25mm



Accessibility 360°  
Front Rear & Side



Fully Pre-equipped  
Adapt to your needs

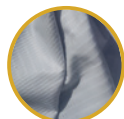

Fiberoptic Liner  
Strong & Removable



100% Lightproof  
Double-flap zip

## INTENSE



Ducting Flange DF25 & Ducting Flange Mobile DFM315

Connector: Ø150 – 160 – 200 – 250mm

MYLAR 900D



#201 Stainless Steel  
Ø25mm

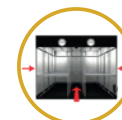

Accessibility +360°  
Full plant access



Fully Pre-equipped  
Adapt to your needs

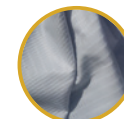

Fiberoptic Liner  
Strong & Integrated



Fully Linkable  
Side & Front



DP60



DP90



DP120

## DARK PROPAGATOR



Ducting Flange DF16

Connector: Ø100 – 125 – 150 mm

MYLAR 210D

DP90 : GRID IN OPTION



**Q195 Steel**  
Ø16 mm



**Removable shelves**  
Option in DP90



**Fully Pre-equipped**  
Adapt to your needs

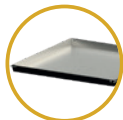

**Water tray**  
Strong & Removable



**100% Lightproof**  
Double-flap zip



L100



L160

## LODGE



Ducting Flange DF16

Connector: Ø100 – 125 – 150 mm

MYLAR 210D

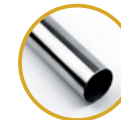

**Q195 Steel**  
Ø16 – 19 mm



**1 Extractor/3 Rooms**  
Full plant access



**Fully Pre-equipped**  
Adapt to your needs

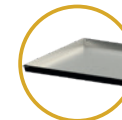

**Water tray**  
Strong & Removable



**100% Lightproof**  
Double-flap zip



## SMALL HYDRO SHOOT



SOCKS

MYLAR 210D



Q195 Steel  
Ø16mm

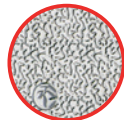

Reflective Mylar  
M210D



High & Small Plants  
Vertical or Horizontal

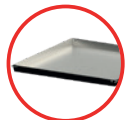

Water tray  
Strong & Removable



100% Lightproof  
Double-flap zip

## LARGE HYDRO SHOOT

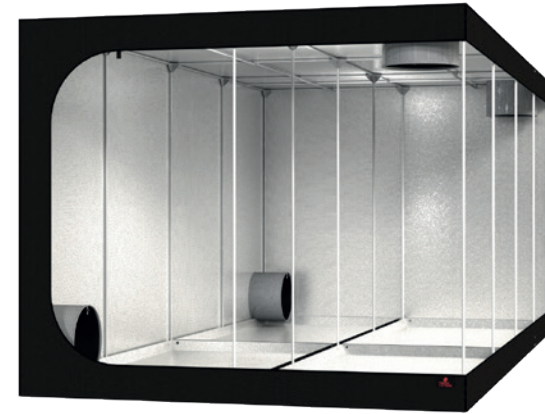

SOCKS

MYLAR 210D



Q195 Steel  
Ø19mm

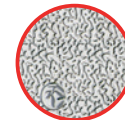

Reflective Mylar  
M210D

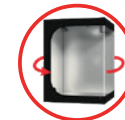

Opening 270°  
Full plant access

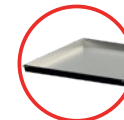

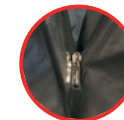

Water tray  
Strong & Removable



100% Lightproof  
Double-flap zip

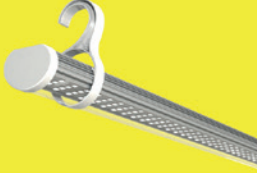

# LIGHTING : PRODUCT POSITIONNING

		
	<b>COSMORROW LED</b>	<b>TLED</b>
<b>TECHNOLOGIE</b>	LED	LED
<b>APPLICATION</b>		
<b>INVESTMENT</b>	\$\$	\$\$\$
<b>CONSUMPTION</b>	\$	\$
<b>DURABILITY</b>	COL ★★☆☆☆ COP ★★★★★	★★★★☆

## LIGHT LEVEL VS GROW STAGE

LEVEL I			LEVEL II			LEVEL III				
0-100	100-200	200-300	300-400	400-500	500-600	600-800	800-1000	1000-1200	1200-1400	1400+
EARLY SPRING SUNLIGHT			SPRING SUNLIGHT			SUMMER SUNLIGHT				
Cutting, Seedling, Vegetative			Growing			Blooming				

# COSMORROW TECHNOLOGY

Compact, solid, water proof, durable, safe (24V)



1. COSMORROW KITS FULL SPECTRUM



2. COSMORROW TNOLED GROW SPECTRUM



3. COSMORROW BOOSTERS UV & IR



4. COSMORROW BULBS & POWER SUPPLIES

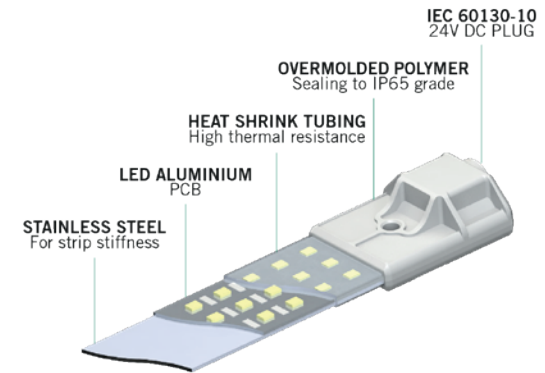

Patent n°W02021176302



**IP65**  
Waterproof



**Strong**  
Fall resistant



**24V Bulbs**  
100% Safe

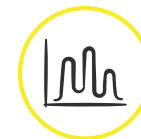

**Custom**  
Spectrum

# COSMORROW KITS : FULL SPECTRUM

## SUMMER SUNLIGHT



**COM60K**



**COM100K**



REFERENCE	DESIGNATION	POWER	GROW AREA	PPE	PPF	PPFD AVERAGE*	BULBS INCULDED	COLOR / LINE	SPECTRUM
<b>COM60K</b>	Cosmorrow 60W FULL SPECTRUM	60W	60x40cm	2.4 $\mu\text{mol/s/W}$	144 $\mu\text{mol/s}$	765 $\mu\text{mol/s/m}^2$	3x COP20BL		
<b>COM100K</b>	Cosmorrow 100W FULL SPECTRUM	100W	60x60cm	2.4 $\mu\text{mol/s/W}$	240 $\mu\text{mol/s}$	728 $\mu\text{mol/s/m}^2$	5x COP20BL		

\* d=15cm

# COSMORROW KITS : 200 – 280 – 360 W\* FULL SPECTRUM

## SUMMER SUNLIGHT



**COM200FS**



**COM200FS + 1x UPGRADE 80W : 280W\***

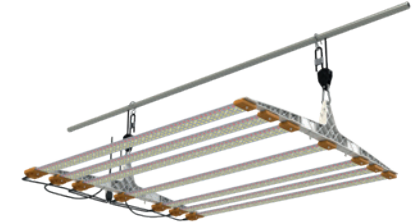

**COM200FS + 2x UPGRADE 80W : 360W\***

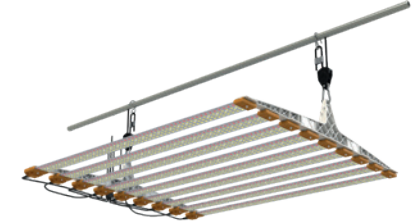

REFERENCE	DESIGNATION	POWER	GROW AREA	PPE (bulb)	PPF	PPFD AVERAGE*2	BULBS INCULDED	COLOR / LINE	SPECTRUM
<b>COM200FS</b>	Cosmorrow 200W FULL SPECTRUM	200W	80x80 cm	2.85 μmol/s/W	540 μmol/s	1122 μmol/s/m <sup>2</sup>	5x COP40FS		
	+1x UPGRADE 80W	280W	90x90 cm	2.85 μmol/s/W	756 μmol/s	1108 μmol/s/m <sup>2</sup>	7x COP40FS		
	+2x UPGRADE 80W	360W	100x100 cm	2.85 μmol/s/W	972 μmol/s	1101 μmol/s/m <sup>2</sup>	9x COP40FS		

\* UPGRADE 80W (sold separately)

**COP40FS** x2 Cosmorrow LED 40W L70cm FULL SPECTRUM

**COM40** x2 Cosmorrow Power 1x40W (Alternative: 1x COM2X40)

\*2 200W : d=20cm / 280W : d=25cm / 360W : d=30cm

# COSMORROW TNOLED : GROW SPECTRUM

## SPRING SUNLIGHT



REFERENCE	DESIGNATION	POWER	GROW AREA	PPE	PPF	PPFD AVERAGE*	INCLUDED BULBS	COLOR / LINE	SPECTRUM
<b>TN04065</b>	TNoled 2x20W GROWING	40W	60x40cm	2.0 $\mu\text{mol/s/W}$	80 $\mu\text{mol/s}$	355 $\mu\text{mol/s/m}^2$	2x COL2065		
<b>TN08065</b>	TNoled 2x40W GROWING	80W	120x40cm	2.0 $\mu\text{mol/s/W}$	160 $\mu\text{mol/s}$	363 $\mu\text{mol/s/m}^2$	2x COL4065	6500 K 6500 K 6500 K	

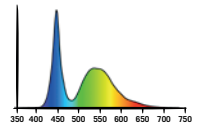

\* d=15cm

# COSMORROW IR & UV BOOSTER (INFRARED & ULTRAVIOLET)



Add a UV or IR booster whenever needed with our single power supply. We recommend using it with a timer separate from the main lighting.

- INFRARED**
- \* Trigger flowering
  - \* Heat up your plant
  - \* Longer internodes

- ULTRAVIOLET**
- \* Boost immune system
  - \* Fights mould
  - \* Shorter internodes

## BULBS

REFERENCE	DESIGNATION	PPF	COLOR / LINE	SPECTRUM	
<b>COL20IR</b>	Cosmorrow Led 20W L50cm IR	34 $\mu\text{mol/s}$	<p>2100 K    730 nm    2100 K</p>		<p>COL20IR</p>
<b>COL20UV</b>	Cosmorrow Led 20W L50cm UV	32 $\mu\text{mol/s}$	<p>6500 K    365 nm    6500 K</p>		<p>COL20UV</p>

## LIGHTING FIXTURE (EXC. BULB)

REFERENCE	DESIGNATION	POWER MAX
<b>COM20</b>	Cosmorrow Power 1x20W	20W





# COSMORROW BULBS & POWER SUPPLY

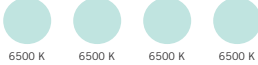
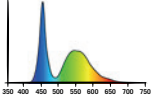

COP20BL

## BULBS

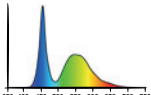
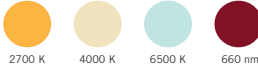
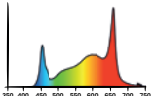
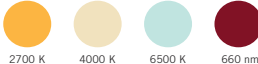
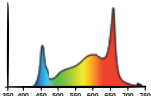
REFERENCE	DESIGNATION	PPE	PPF	COLOR / LINE	SPECTRUM
<b>COP2065</b>	Cosmorrow Led 20W L50cm GROW	2.7 $\mu\text{mol/s/W}$	54 $\mu\text{mol/s}$	 6500 K 6500 K 6500 K 6500 K	
<b>COL4065</b>	Cosmorrow Led 40W L90cm GROW	2.0 $\mu\text{mol/s/W}$	80 $\mu\text{mol/s}$	 6500 K 6500 K 6500 K	
<b>COP20BL</b>	Cosmorrow Led 20W L50cm FULL SPECTRUM	2.4 $\mu\text{mol/s/W}$	48 $\mu\text{mol/s}$	 2700 K 4000 K 6500 K 660 nm	
<b>COP40FS</b>	Cosmorrow Led 40W L70cm FULL SPECTRUM	2.85 $\mu\text{mol/s/W}$	114 $\mu\text{mol/s}$	 2700 K 4000 K 6500 K 660 nm	

## LIGHTING FIXTURE (EXC. BULB)

REFERENCE	DESIGNATION	POWER MAX
<b>COM20</b>	Cosmorrow Power 1x20W	20W
<b>COM40</b>	Cosmorrow Power 1x40W	40W



# TLED

A 50.000-HOUR LIFETIME



TLED4625



TLED2630

## BULBS

REFERENCE	DESIGNATION	PPE	PPF	SPECTRUM
<b>TLED2630</b>	TLED 26W L 54cm FULL SPECTRUM	2.0 $\mu\text{mol/s/W}$	52 $\mu\text{mol/s}$	
<b>TLED4230</b>	TLED 42W L 95cm FULL SPECTRUM	2.0 $\mu\text{mol/s/W}$	84 $\mu\text{mol/s}$	
<b>TLED2665</b>	TLED 26W L 54cm GROWING	2.0 $\mu\text{mol/s/W}$	52 $\mu\text{mol/s}$	
<b>TLED4265</b>	TLED 42W L 95cm GROWING	2.0 $\mu\text{mol/s/W}$	84 $\mu\text{mol/s}$	

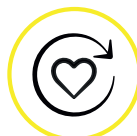
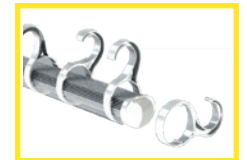
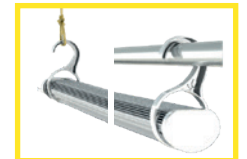

Durability



Easy to install



Compact



# VENTILATION



## 1. EXTRACTORS & FILTERS



## 2. DUCTING FLANGE



## 3. MONKEY FAN



# EXTRACTOR & FILTERS : LAYOUT



## DF16 EXTRACTORS

**DF16E150** DF16 – 50/100/150m<sup>3</sup>/h



**DF16E350** DF16 – 150/250/350m<sup>3</sup>/h



## DF16 FILTERS

**DF16F100**

0.4Kg – 100m<sup>3</sup>/h



**DF16F150**

1.0Kg – 150m<sup>3</sup>/h



**DF16F250**

1.5Kg – 250m<sup>3</sup>/h



**DF16F350**

2.0Kg – 350m<sup>3</sup>/h



## DF16 CONNECTORS

**DF16100**

DF16 – Ø100mm



**DF16125**

DF16 – Ø125mm



**DF16150**

DF16 – Ø150mm



**DF16 Technology**  
No tools needed



**EC Motor**  
24V



**Max/Min Airflow**  
User controlled

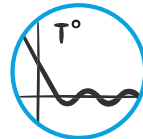

**Intelligent Speed Control**



**High Quality Carbon**

## 2 THERMAL SENSORS

### CONFIGURATION 2

2<sup>nd</sup> THERMAL SENSOR

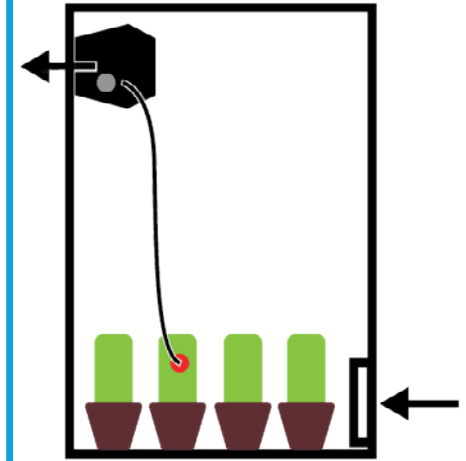

### CONFIGURATION 1

INTEGRATED SENSOR

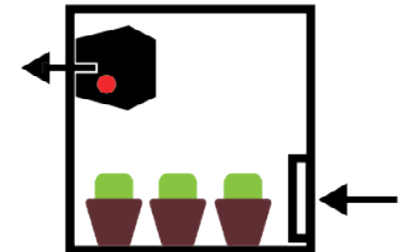

# EXTRACTOR & FILTERS



## CONNECT TO REGULAR DUCTING



### EXAMPLES USING CONNECTORS



## CONNECT TO DUCTING FLANGE



### EXAMPLES WITH DUCTING FLANGE



### MALES : DEVICES

Extractor



Filter



Connector



### FEMALES : LINKS

Ducting Flange\*

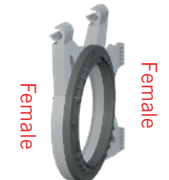

Ring\*\*



\* Includes a recess for Light Baffle  
 \*\* Extractors include two rings

# DUCTING FLANGE



## CONNECT SECRET JARDIN PERIPHERALS TO YOUR TENT



### DUCTING FLANGE

- DF16** Kit for 16 to 19mm poles
- DF25** Kit for 25mm poles



### EXTRACTOR

- DF16E350** DF16 Extractor T° 150/250/350m³/h
- DF16E150** DF16 Extractor T° 50/100/150m³/h

### FILTER

- DF16F100** DF16 Filter CTC80 0.4 kg 100m³/h
- DF16F150** DF16 Filter CTC80 1.0 kg 150m³/h
- DF16F250** DF16 Filter CTC80 1.5 kg 250m³/h
- DF16F350** DF16 Filter CTC80 2.0 kg 350m³/h

### CONNECTOR

For DF16 : Ø100 – Ø125 – Ø150 mm  
 For DF25 : Ø150 – Ø160 – Ø200 – Ø250 mm

## CREATE PASSIVE INTAKES

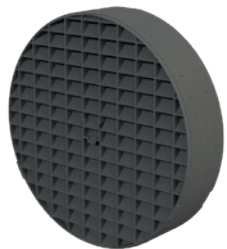

### LIGHT BAFFLE

- DF16LB** DF16 Light Baffle with Mesh
- DF25LB** DF25 Light Baffle with Mesh

- Lightproof
- Increase your airflow or decrease your extraction needs
- Reduces stress on the tent
- Homogenize your tent atmosphere

### SINGLE INTAKE



### MULTIPLE INTAKES



## CREATE A Ø315 mm CONNECTION FLANGE



### DFM315K

### MOBILE DUCTING FLANGE Ø315 mm

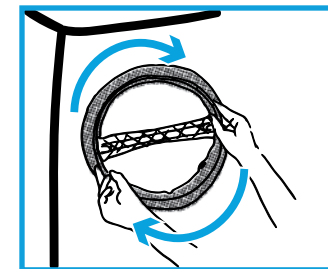

Cutting tool is included



**Easy to install**  
On poles or tent fabric



**Choose your placement**  
Front, sides, backside, tent roof



**Robust Design**  
Supporting up to 3kg



**Can be plugged up**  
PatchIT 16 & 25 (Spare Parts)



Cutting tool is included



**Through any flexible wall**  
Up to 2.5mm thickness



**Easy to install**  
No screw needed



**Choose your placement**  
Front, sides, backside, tent roof

# MONKEY FAN

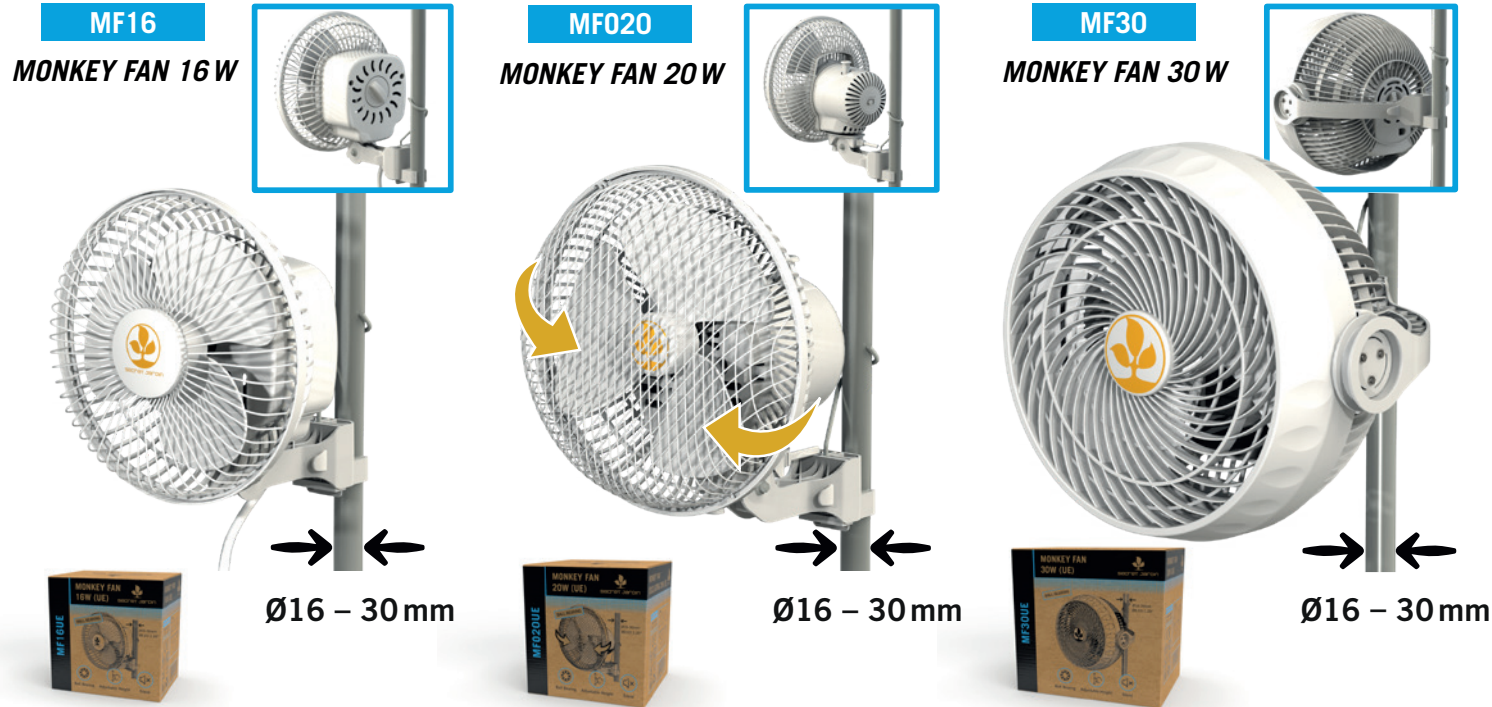

**CAUTION (MF020)**

**SPACE BOOSTER**

Space Booster

With Space Booster **YES**

Without Space Booster **NO**

**CABLE POSITION**

**YES**

**NO**

**DURABILITY IN CLEAN ENVIRONMENT (LIFE TIME)**

24/24 h = 6 months

12/24 h = 12 months

6/24 h = 24 months



Ball Bearing



Height Adjustable



Silent

# GROW TENTS BUNDLES



## 1. CLONING KITS



## 2. GROWING KITS



## 3. FULL SPECTRUM KITS



## GROW TENTS BUNDLES



### DP60CL

**CLONING KIT**  
60x40x60 cm

The most compact solution for cloning application.

This bundle is made to fit one cloning tray. Easily maintain an high relative humidity thanks to the closed atmosphere.



### DP60GR

**GROWING KIT**  
60x40x60 cm

Ideal space to host seedlings, cuttings or mother plants

This bundle is perfect to offer a complementary room to your setup. The early spring sunlight will fit all stage up to beginning of growing.



### DP90GR

**GROWING KIT**  
90x60x98 cm

Ideal bundle for seedlings, mother plants and growing stage

This bundle offers a 90x60cm space ideal for growing. The height of the lamps can be adjusted to suit different heights of plants.

#	REFERENCE	DESIGNATION
1x	DP60	Dark Propagator 60x40x60cm
1x	COP2065	Cosmorrow Led 20W GROWING
1x	COM20	Cosmorrow Power 1x20W

#	REFERENCE	DESIGNATION
1x	DP60	Dark Propagator 60x40x60cm
1x	COP2065	Cosmorrow Led 20W GROWING
1x	COM20	Cosmorrow Power 1x20W
1x	DF16E150	DF16 Extractor T° 50/100/150 m³/h
OPTION	DF16F100	DF16 Filter CTC80 0.4kg 100m³/h

#	REFERENCE	DESIGNATION
1x	DP90	Dark Propagator 90x60x98 cm
2x	TN04065	TNled 2x20W GROWING
1x	DF16E150	DF16 Extractor T° 50/100/150 m³/h
OPTION	DF16F100	DF16 Filter CTC80 0.4kg 100m³/h
OPTION	MF16BB	Monkey Fan 16W Ball Bearing

1x COP2065 – Average PPFD: 305µmol/s/m², d=15cm

1x COP2065 – Average PPFD: 305µmol/s/m², d=15cm

2x TN04065 – Average PPFD: 312µmol/s/m², d=15cm



**Energy saving**  
LED technology



**24 V**  
100% Safe



**Closed environment**  
Easy high humidity



**Easy assembly**  
No tools required



**All in one**  
Light & Extraction included



**24 V**  
100% Safe



**Controlled atmosphere**  
Temperature



**Easy assembly**  
No tools required



**All in one**  
Light & Extraction included



**24 V**  
100% Safe



**Controlled atmosphere**  
Temperature



**Easy assembly**  
No tools required

## GROW TENTS BUNDLES



### DP120GR

**GROWING KIT**  
120x60x190 cm

Convert 0,7 m<sup>2</sup> into up to 3,2 m<sup>2</sup> of seedlings, cutting and mother plants all year round

Seedling, cutting, mother plant all in one tent for professional growers. Remove grids and reposition lamps to create higher spaces with higher light intensity.



### DS60FS

**FULL SPECTRUM KIT**  
60x60x158 cm

60x60 cm full spectrum setup ideal for a whole cycle from seed to harvest

It will provide a summer sunlight to your plants (PPFD > 600). Remove LED strips to dim your lighting and create a growing stage setup.



### DS90FS

**FULL SPECTRUM KIT**  
90x90x178 cm

90x90 cm full spectrum setup ideal for a whole cycle from seed to harvest

It will provide a summer sunlight to your plants (PPFD > 600). Remove LED strips to dim your lighting and create a growing stage setup or add optional COP40FS for higher intensity lighting.

#	REFERENCE	DESIGNATION
1x	DP120	Dark Propagator 120x60x190 cm
5x	COL4065	Cosmorrow Led 40W GROWING
5x	COM40	Cosmorrow Power 1x40W
1x	DF16E150	DF16 Extractor T° 50/100/150 m <sup>3</sup> /h
OPTION	DF16F100	DF16 Filter CTC80 0.4kg 100 m <sup>3</sup> /h
OPTION	MF16BB	Monkey Fan 16W Ball Bearing

#	REFERENCE	DESIGNATION
1x	DS60	Dark Street 60x60x158 cm
1x	COM100K	Cosmorrow Kit 100W Full Spectrum
1x	DF16E150	DF16 Extractor T° 50/100/150 m <sup>3</sup> /h
1x	DF16F150	DF16 Filter CTC80 1.0kg 150 m <sup>3</sup> /h
1x	MF16BB	Monkey Fan 16W Ball Bearing

#	REFERENCE	DESIGNATION
1x	DS90	Dark Street 90x90x178 cm
1x	COM200FS	Cosmorrow Kit 200W Full Spectrum
1x	DF16E350	DF16 Extractor T° 150/250/350 m <sup>3</sup> /h
1x	DF16F250	DF16 Filter CTC80 1.5kg 250 m <sup>3</sup> /h
1x	MF020BB	Monkey Fan 20W Osc. Ball Bearing

OPTION	UPGRADE 80W :	
2x	COP40FS	Cosmorrow Led 40W Full Spectrum
2x	COM40	Cosmorrow Power 1x40W

1x COL4065 – Average PPFD: 120µmol/s/m<sup>2</sup>, d=15cm

1x COM100K – Average PPFD: 728µmol/s/m<sup>2</sup>, d=15cm

1x COM200FS – Average PPFD: 790µmol/s/m<sup>2</sup>, d=20cm  
1x COM200FS + 1x UPGRADE 80W – Average PPFD: 1101µmol/s/m<sup>2</sup>, d=25cm



All in one  
Light & Extraction included



24V  
100% Safe



Controlled atmosphere  
Temperature



Easy assembly  
No tools required



All in one  
Light & Extraction included



Full Spectrum  
Fits for full crop cycle



Controlled atmosphere  
Temperature



Easy assembly  
No tools required



All in one  
Light & Extraction included



Full Spectrum  
Fits for full crop cycle



Controlled atmosphere  
Temperature



Easy assembly  
No tools required



# GROW TENTS BUNDLES



## DS120WFS

**FULL SPECTRUM KIT**  
120x60x178 cm

120x60cm full spectrum setup ideal for a whole cycle from seed to harvest

This setup will provide a summer sunlight to your plants (PPFD > 600). Adjust the height of the 2 lighting systems separately to follow your plant growth. Remove LED strips to dim your lighting and create a growing stage setup.

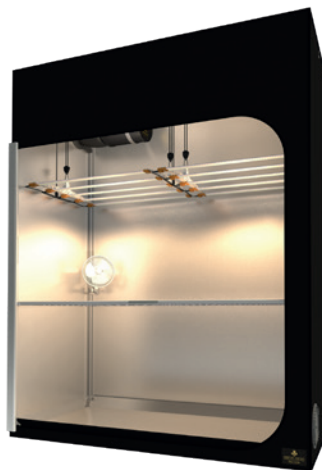

## DS150WFS

**FULL SPECTRUM KIT**  
150x77x200 cm

150x77 cm full spectrum setup ideal for a whole cycle from seed to harvest

It will provide a summer sunlight to your plants (PPFD > 600). Adjust the height of the 2 lighting systems separately to follow your plant growth. Remove LED strips to dim your lighting and create a growing stage setup.



## L100FS

**FULL SPECTRUM KIT**  
100x60x158 cm

Non-stop harvest with a 3x rooms tent: cutting & mother plant, growing and flowering

This bundle allows you to have 3 different grow stages in one tent. Light intensity and spectrum is dimensionned for each areas. Use only one extractor to control temperature in the whole tent thanks to the Ducting Flange system!

#	REFERENCE	DESIGNATION
1x	DS120W	Dark Street 120x60x178 cm
2x	COM100K	Cosmorrow Kit 100W Full Spectrum
1x	DF16E350	DF16 Extractor T° 150/250/350m³/h
1x	DF16F250	DF16 Filter CTC80 1.5kg 250m³/h
1x	MF020BB	Monkey Fan 20W Osc. Ball Bearing

#	REFERENCE	DESIGNATION
1x	DS150W	Dark Street 150x77x200cm
2x	COM200FS	Cosmorrow Kit 200W Full Spectrum
1x	DF16E350	DF16 Extractor T° 150/250/350m³/h
1x	DF16F350	DF16 Filter CTC80 2.0kg 350m³/h
1x	MF020BB	Monkey Fan 20W Osc. Ball Bearing

#	REFERENCE	DESIGNATION
1x	L100FS	Lodge 100x60x158cm
1x	COM100K	Cosmorrow Kit 100W Full Spectrum
1x	TN04065	TNoled 2x20W GROWING
1x	COP2065	Cosmorrow Led 20W GROWING
1x	COM20	Cosmorrow Power 1x20W
1x	DF16LB	DF16 Light Baffle with Mesh
1x	DF16E150	DF16 Extractor T° 50/100/150m³/h
1x	DF16F150	DF16 Filter CTC80 1.0kg 150m³/h
1x	MF16BB	Monkey Fan 16W Ball Bearing

2x COM100K – Average PPFD: 773µmol/s/m², d=15cm

2x COM200FS– Average PPFD: 1153µmol/s/m², d=20cm

1x COM100K – Average PPFD: 728µmol/s/m², d=15cm  
 1x COP2065 – Average PPFD: 305µmol/s/m², d=15cm  
 1x TN04065 – Average PPFD: 355µmol/s/m², d=15cm



**All in one**  
Light & Extraction included



**Full Spectrum**  
Fits for full crop cycle



**Controlled atmosphere**  
Temperature



**Easy assembly**  
No tools required



**All in one**  
Light & Extraction included



**Full Spectrum**  
Fits for full crop cycle



**Controlled atmosphere**  
Temperature



**Easy assembly**  
No tools required



**All in one**  
Light & Extraction included



**3 grow areas**  
Fits for full crop cycle



**Controlled atmosphere**  
Temperature



**Easy assembly**  
No tools required

# ACCESSORIES



## 1. DRYERS

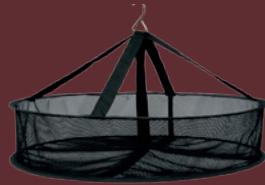

## 2. WEB PLANT SUPPORTS

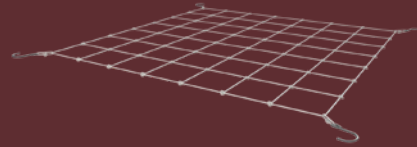

## 3. REMOVABLE WATER TRAY

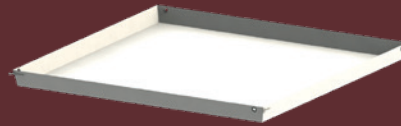

## 3. CABLES & WATER PIPES INSTALLATIONS



## 3. SUPPORT & REINFORCEMENT



## 6. TENT REPAIR KITS



## DRY IT



**DRYIT45**

*Ø45 cm LINKABLE*



**DRYIT90**

*Ø80 cm 5 LAYERS H 150 cm*



# WEB PLANT SUPPORT

WEBTH: Thread / small sizes – WEBIT: Elastic / Large sizes



## WEBTH

THREAD WEB PLANT SUPPORT

## WEBIT

ELASTIC WEB PLANT SUPPORT

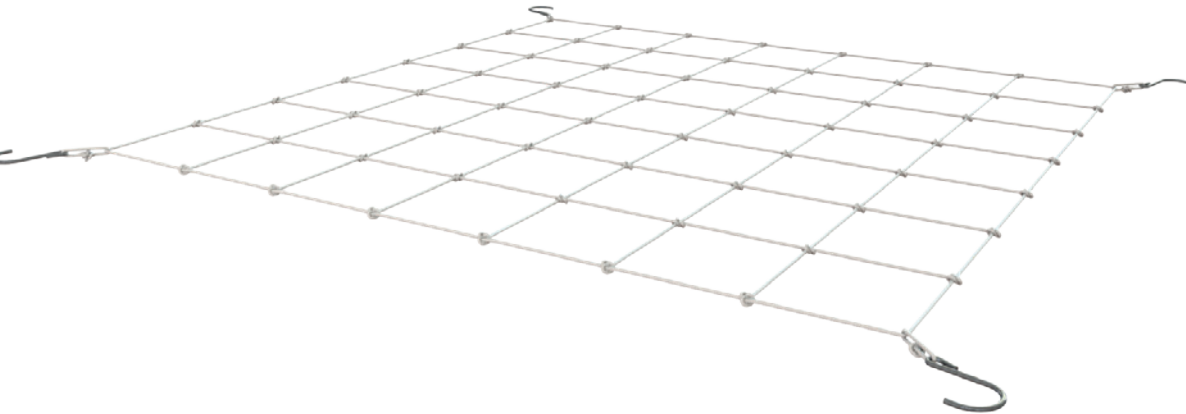

## WEBTH

THREAD

<b>WEBTH60</b>	<b>60x60 cm</b>
<b>WEBTH90</b>	<b>90x90 cm</b>
<b>WEBTH120</b>	<b>120x120 cm</b>
<b>WEBTH120W</b>	<b>120x60 cm</b>
<b>WEBTH150W</b>	<b>150x75 cm</b>

**Mesh Size**  
= 10x10 cm

## WEBIT

ELASTIC

<b>WEBIT120</b>	<b>120x120 cm</b>
<b>WEBIT150</b>	<b>150x150 cm</b>
<b>WEBIT240W</b>	<b>240x120 cm</b>
<b>WEBIT300W</b>	<b>300x150 cm</b>

**Mesh Size**  
≈ 12x12 cm

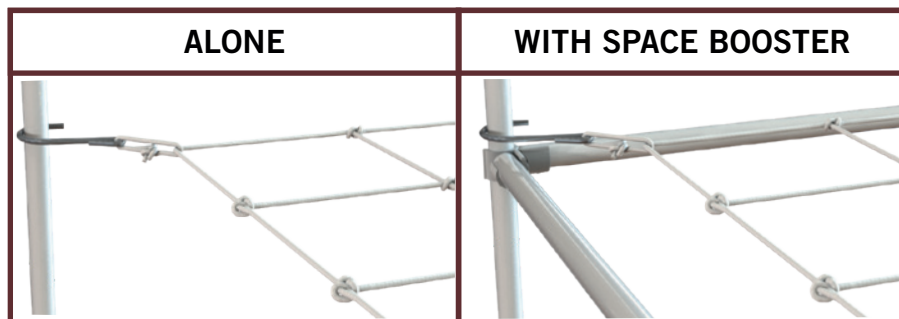

## REMOVABLE WATER TRAY

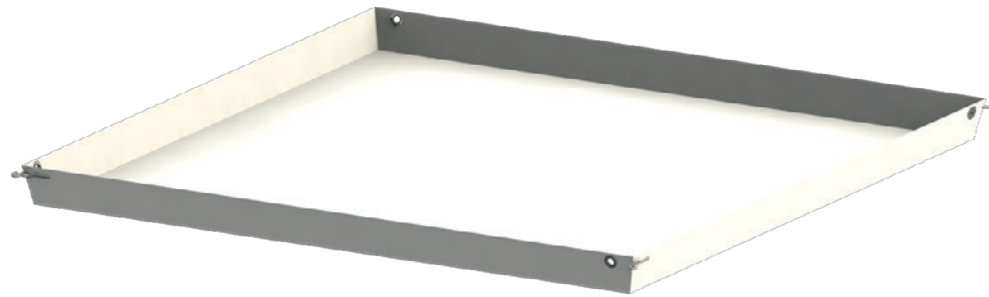

<b>WTL60</b>	<b><i>60x60x5 cm</i></b>
<b>WTL90</b>	<b><i>90x90x5 cm</i></b>
<b>WTL120</b>	<b><i>120x120x5 cm</i></b>
<b>WTL150</b>	<b><i>150x150x5 cm</i></b>

<b>WTL120W</b>	<b><i>120x60x5 cm</i></b>
<b>WTL150W</b>	<b><i>150x75x5 cm</i></b>
<b>WTL240W</b>	<b><i>240x120x5 cm</i></b>
<b>WTL300W</b>	<b><i>300x150x5 cm</i></b>

# CABLES & WATER PIPES INSTALLATIONS



**CABLEIT16**

**FOR POLE  
Ø16mm**



**CABLEIT19**

**FOR POLE  
Ø19mm**



**CABLEIT25**

**FOR POLE  
Ø25mm**

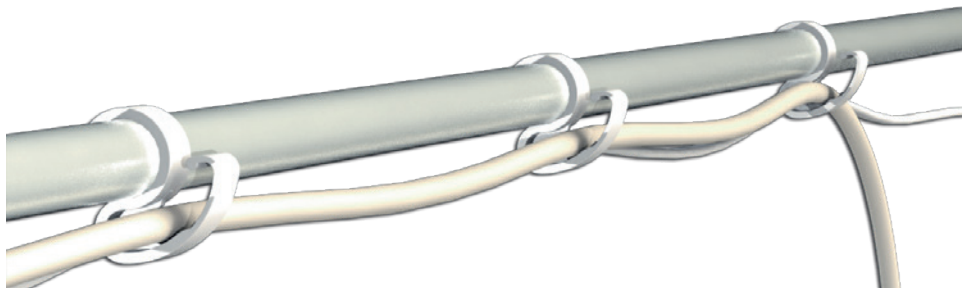

**FOR ALL GROW TENTS**

**CF7D**

**KIT CABLE FLANGE DOUBLE SOCKS**

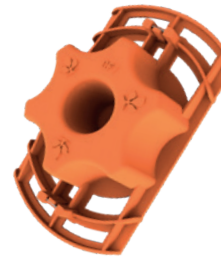

Fits anywhere



Can be plugged up  
PatchIT7 (Spare Parts)



Easy to install

# SUPPORTS & REINFORCEMENT



## SPACE BOOSTER

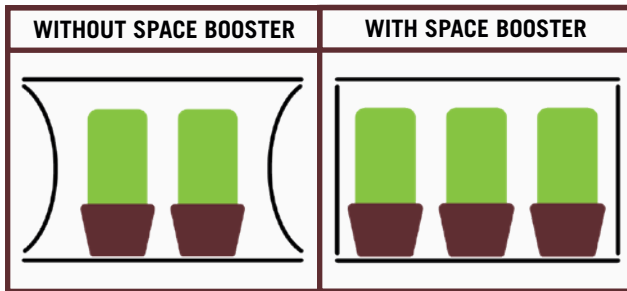
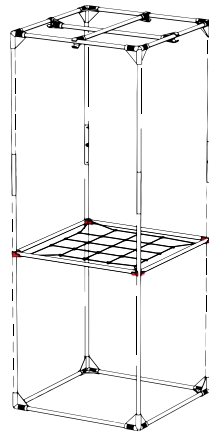
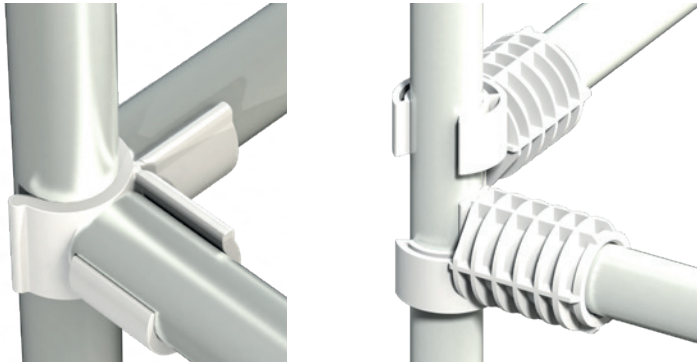

Up to 25% more space



Reinforces your tent



Supports the WebIT



Height Adjustable

## HANDLING

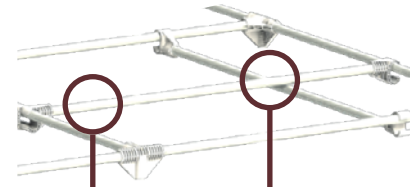

1 pole	2 cross poles	
10 kg max	20 kg max	Ø16 mm
15 kg max	30 kg max	Ø19 mm
25 kg max	50 kg max	Ø25 mm

### 2 CORNERS POSITIONS

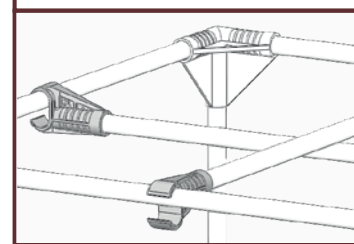

Solid holder



Secure Attachment  
Double hook system

## SUPPORT IT

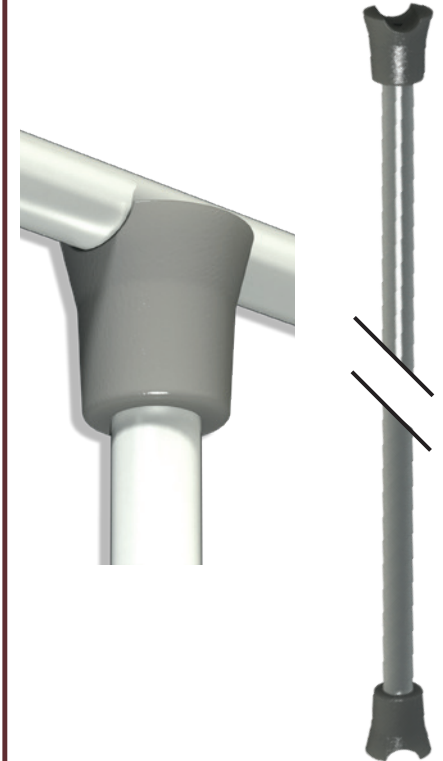

Easy set up



Reinforces your tent

# SUPPORTS & REINFORCEMENT



## DARK STREET

REF	DESIGNATION	STRUCTURE					HANDLING POLES INCLUDED					SPACE BOOSTER INCLUDED				
		DS60	DS90	DS120	DS120W	DS150W	DS60	DS90	DS120	DS120W	DS150W	DS60	DS90	DS120	DS120W	DS150W
T16-60	Pole Ø16 mm 360 mm	12			4		2					4			2	
T16-90	Pole Ø16 mm 860 mm		16		8			2				4			4	
T16-100	Pole Ø16 mm 960 mm	4														
T16-120	Pole Ø16 mm 1160 mm				4				2						2	
T16-Link	Link Ø16 mm				4											
C16-Y	Corner Ø16 mm 3 axes Y shape	8	8		8											
C16-H	Handling Corner Ø16 mm						2	4		2						
C16-SB	Space Booster Ø16 mm										4	4			4	
T19-75	Pole Ø19 mm 726 mm					12								4		6
T19-100	Pole Ø19 mm 975 mm			8		8										
T19-120	Pole Ø19 mm 1153 mm			8					2					4		
T19-Link	Link Ø19 mm			4		8							2			2
C19-Y	Corner Ø19 mm 3 axes Y shape				8	8										
C19-H	Handling Corner Ø19 mm							4			4					
C19-SB	Space Booster Ø19 mm													4		4

## DARK ROOM

REF	DESIGNATION	STRUCTURE					HANDLING POLES INCLUDED					SPACE BOOSTER INCLUDED					
		DR150	DR240	DR300	DR240W	DR300W	DR150	DR240	DR300	DR240W	DR300W	DR150	DR240	DR300	DR240W	DR300W	
T25-75	Pole Ø25 mm 717 mm	16		40		26	6			20		10	8		24		16
T25-100	Pole Ø25 mm 967 mm	4	18	9	12	6							9				4
T25-120	Pole Ø25 mm 1134 mm	4	20	9	13	6			9		5			12		8	
T25-Link	Link Ø25 mm	12	9	29	6	19	3		10			5	4		12		8
C25-Y	Corner Ø25 mm 3 axes Y shape	8	8	8	8	8											
C25-K	Corner Ø25 mm 4 axes K shape		4	4	2	2											
C25-T	Corner Ø25 mm 3 axes T shape		4	4	2	2											
C25-XI	Corner Ø25 mm 5 axes XI shape		1	1													
C25-H	Handling Corner Ø25 mm						6	18	20	10	10						
C25-SB	Space Booster Ø25 mm											8	24	24	16	16	
C25-RF	Rubber Feet Ø25 mm		1	1													

## HYDRO SHOOT (SMALL)

REF	DESIGNATION	STRUCTURE				HANDLING POLES INCLUDED			
		HS40	HS60	HS80	HS100	HS40	HS60	HS80	HS100
T16-40	Pole Ø16 mm 360 mm	8				2			
T16-60	Pole Ø16 mm 560 mm	8	8				2		
T16-80	Pole Ø16 mm 760 mm		8	8				2	
T16-90	Pole Ø16 mm 860 mm			8					
T16-100	Pole Ø16 mm 960 mm				16				2
T16-Link	Link Ø16 mm	4	4	4	4				
C16-Y	Corner Ø16 mm 3 axes Y shape	8	8	8	8				
C16-H	Handling Corner Ø16 mm					4	4	4	4

## HYDRO SHOOT (LARGE)

REF	DESIGNATION	STRUCTURE								HANDLING POLES INCLUDED								
		HS120	HS150	HS240	HS300	HS240W	HS300W	HS480W	HS600W	HS120	HS150	HS240	HS300	HS240W	HS300W	HS480W	HS600W	
T19-75	Pole Ø19 mm 726 mm		16		40		26		72					4		10	6	20
T19-100	Pole Ø19 mm 975 mm	8	8	18	18	12	12	30	30									
T19-120	Pole Ø19 mm 1153 mm	8		20		13		36		2		5		3		10		
T19-Link	Link Ø19 mm	4	12	9	29	6	19	15	51				5		3		10	
C19-Y	Corner Ø19 mm 3 axes Y shape	8	8	8	8	8	8	8	8									
C19-K	Corner Ø19 mm 4 axes K shape			8	8	4	4	16	16									
C19-XI	Corner Ø19 mm 5 axes XI shape			1	1			4	4									
C19-H	Handling Corner Ø19 mm									4	4	10	10	6	6	20	20	
C19-RF	Rubber Feet Ø19 mm			1	1			2	2									

## DARK PROPAGATOR

REF	DESIGNATION	STRUCTURE			HANDLING POLES		
		DP60	DP90	DP120	DP60	DP90	DP120
T16-40	Pole Ø16 mm 360 mm	4	4	20			
T16-60	Pole Ø16 mm 560 mm	8	8	6	1	2	
T16-90	Pole Ø16 mm 860 mm		6				
T16-120	Pole Ø16 mm 1160 mm			12			1
C16-Y	Corner Ø16 mm 3 axes Y shape	8	8	8			
C16-K	Corner Ø16 mm 4 axes K shape			4			
C16-T	Corner Ø16 mm 3 axes T shape		4	12			
C16-H	Handling Corner Ø16 mm				2	2	2
GRID6040	Grid 60 x 40 cm	-	Option	12			

## LODGE

REF	DESIGNATION	STRUCTURE		HANDLING POLES INC.		SPACE BOOSTER INC.	
		L100	L160	L100	L160	L100	L160
T16-40	Pole Ø16 mm 360 mm	5	5				
T16-60	Pole Ø16 mm 560 mm	22		3		4	
T16-100	Pole Ø16 mm 960 mm	8	16				
T16-120	Pole Ø16 mm 1160 mm		14		3		4
T16-Link	Link Ø16 mm	4					
C16-Y	Corner Ø16 mm 3 axes Y shape	16	16				
C16-K	Corner Ø16 mm 4 axes K shape	2	2				
C16-T	Corner Ø16 mm 3 axes T shape	2	2				
C16-H	Handling Corner Ø16 mm			6	6		
C16-SB	Space Booster Ø16 mm					4	4
GRID6040	Grid 60 x 40 cm	1	2				

## INTENSE

REF	DESIGNATION	STRUCTURE		HANDLING POLES INC.		SPACE BOOSTER INC.	
		INT480	INT600	INT480	INT600	INT480	INT600
T25-60	Pole Ø25 mm 600 mm	8	8				
T25-75	Pole Ø25 mm 717 mm		80		20		48
T25-120	Pole Ø25 mm 1134 mm	80	40	10		24	
T25-Link	Link Ø25 mm	20	60		10		24
C25-Y	Corner Ø25 mm 3 axes Y shape	8	8				
C25-K	Corner Ø25 mm 4 axes K shape	12	12				
C25-T	Corner Ø25 mm 3 axes T shape	10	10				
C25-XI	Corner Ø25 mm 5 axes XI shape	6	6				
C25-H	Handling Corner Ø25 mm			20	20		
C25-SB	Space Booster Ø25 mm					48	48
C25-RF	Rubber Feet Ø25 mm	6	6				



# SUPPORTS & REINFORCEMENT



## CARRYIT

**BALLAST SUPPORT 13x36 cm 10Kg**

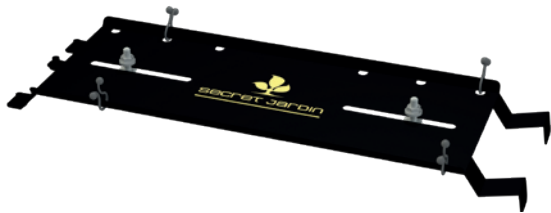

## BALLAST MAX

**Dimensions: 11 x 35 cm**  
**Weight: 10kg**

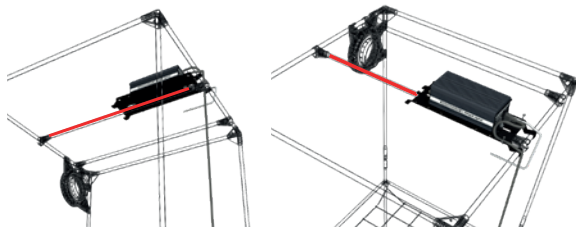

## GRID6040

**60x40 cm**

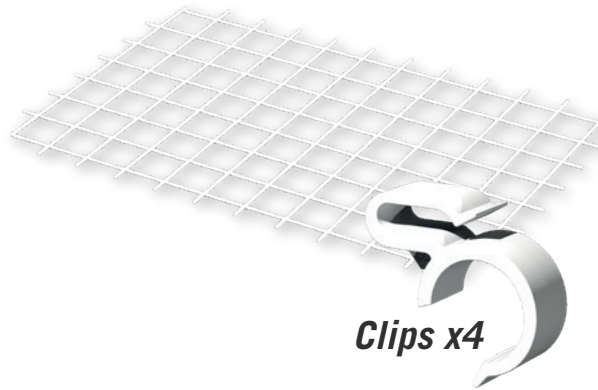

**Clips x4**

**WITH OPTION GRID x1**

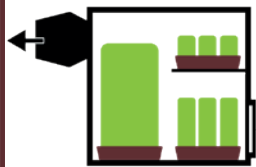

**WITH OPTION GRID x2**

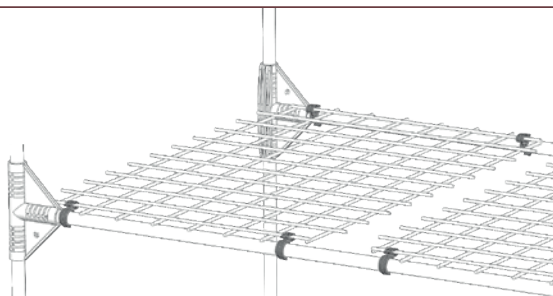
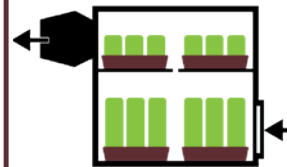

## STRAPIT45

**2x StrapIT**  
**Ø45 cm / 30 kg each**

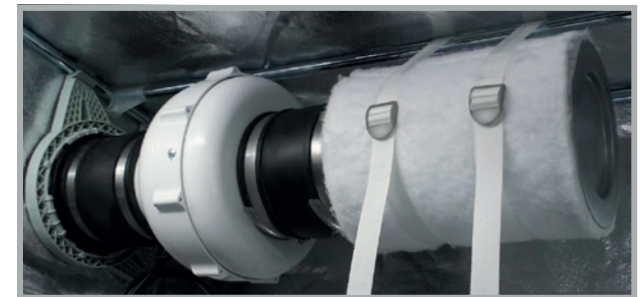

## TENT REPAIR KITS



### PATCHIT7

Ø100 mm

*PatchIT Mylar/Fabric (CF7D)*

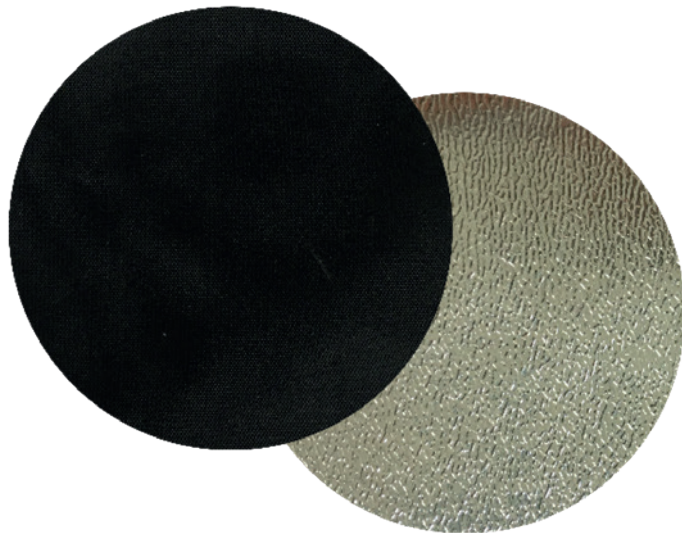

### PATCHIT16

Ø220 mm

*PatchIT Mylar/Fabric (DF16)*

### PATCHIT25

Ø350 mm

*PatchIT Mylar/Fabric (DF25)*

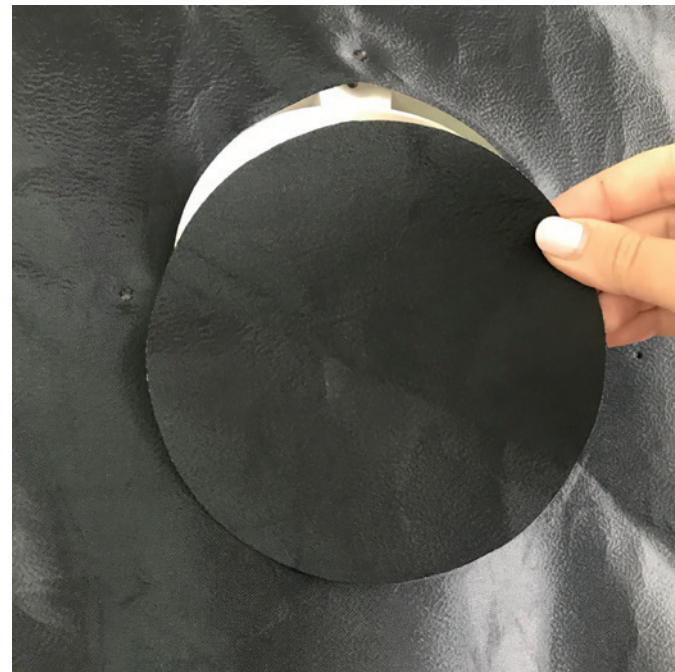

## SPARE PARTS : 36 parts for all SJ & HS tents



T16-40	360 mm
T16-60	560 mm
T16-80	760 mm
T16-90	860 mm
T16-100	960 mm
T16-120	1160 mm

**POLES**  
Ø16 mm

**T16-LINK**  
**LINK**

**C16-Y**  
**CORNER 3 AXES**



**C16-T**  
**CORNER 3 AXES**



**C16-K**  
**CORNER 4 AXES**



**C16-XI**  
**CORNER 5 AXES**

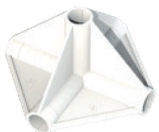

**C16-H**  
**HANDLING CORNER**



**C16-SB**  
**SPACE BOOSTER**



**C16-RF**  
**RUBBER FEET**



T19-75	726 mm
T19-100	975 mm
T19-120	1152 mm
T19-LINK	LINK

**POLES**  
Ø19 mm

**C19-Y**  
**CORNER 3 AXES**



**C19-K**  
**CORNER 4 AXES**

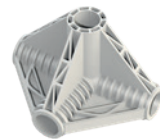

**C19-XI**  
**CORNER 5 AXES**



**C19-H**  
**HANDLING CORNER**



**C19-SB**  
**SPACE BOOSTER**



**C19-RF**  
**RUBBER FEET**



T25-60	600 mm
T25-75	717 mm
T25-100	967 mm
T25-120	1134 mm
T25-LINK	LINK

**POLES**  
Ø25 mm

**C25-Y**  
**CORNER 3 AXES**



**C25-T**  
**CORNER 3 AXES**



**C25-K**  
**CORNER 4 AXES**

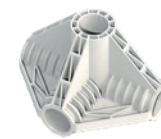

**C25-XI**  
**CORNER 5 AXES**



**C25-H**  
**HANDLING CORNER**



**C25-SB**  
**SPACE BOOSTER**



**C25-RF**  
**RUBBER FEET**



